

KONSTRUKCIJE ZA DVOSTREŠNE I VIŠESTREŠNE KROVOVE

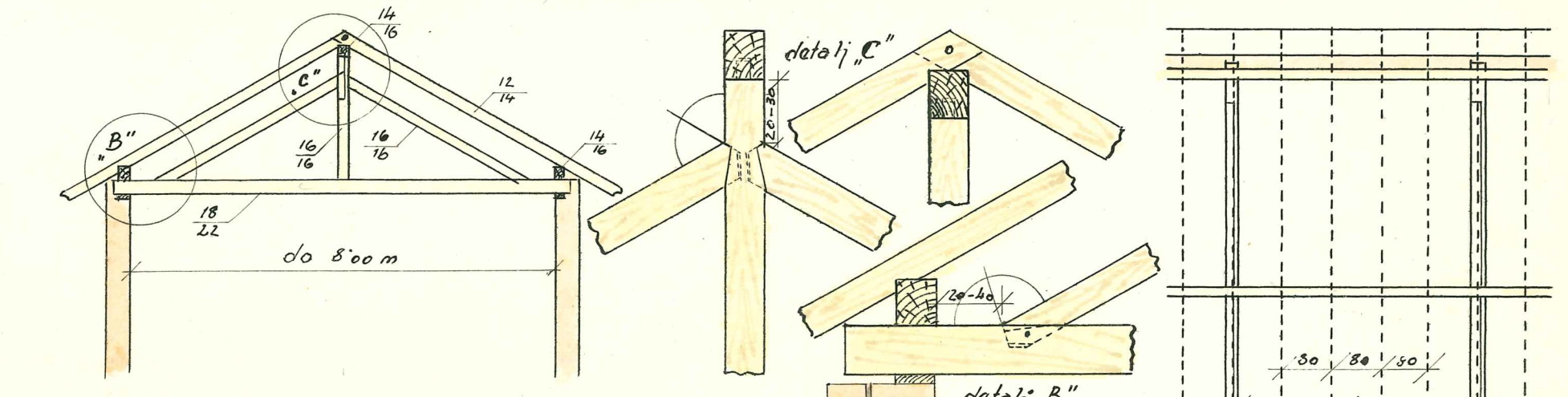

horizontalno rješenje jednostruke stolice

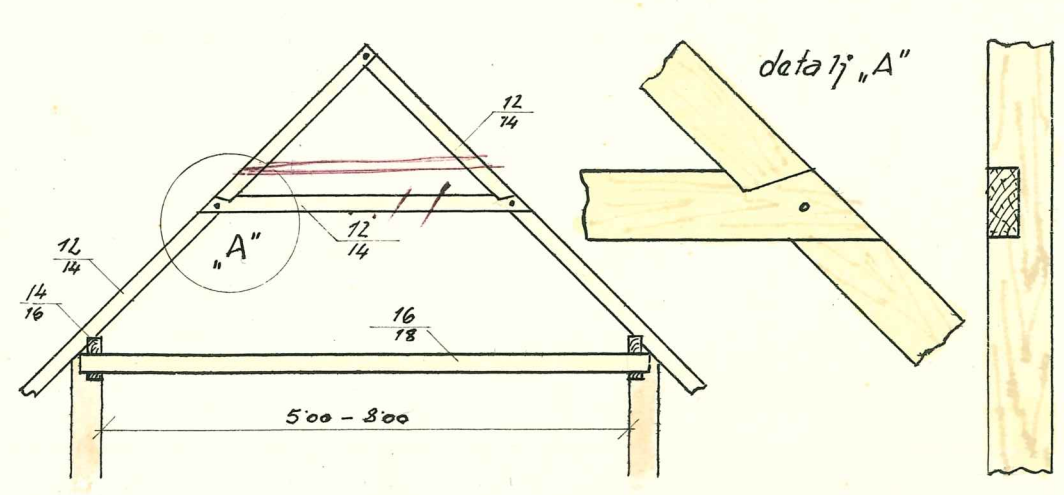
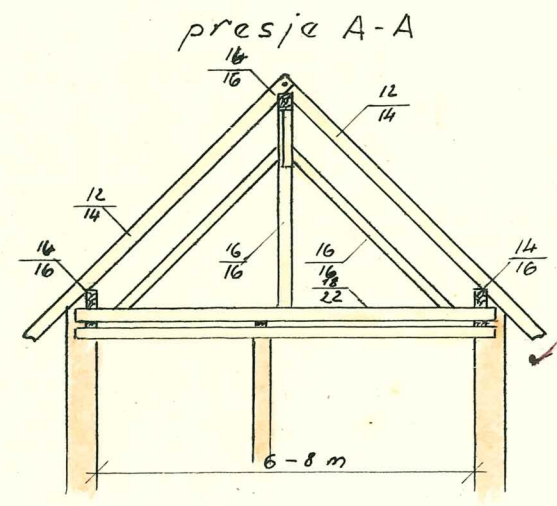
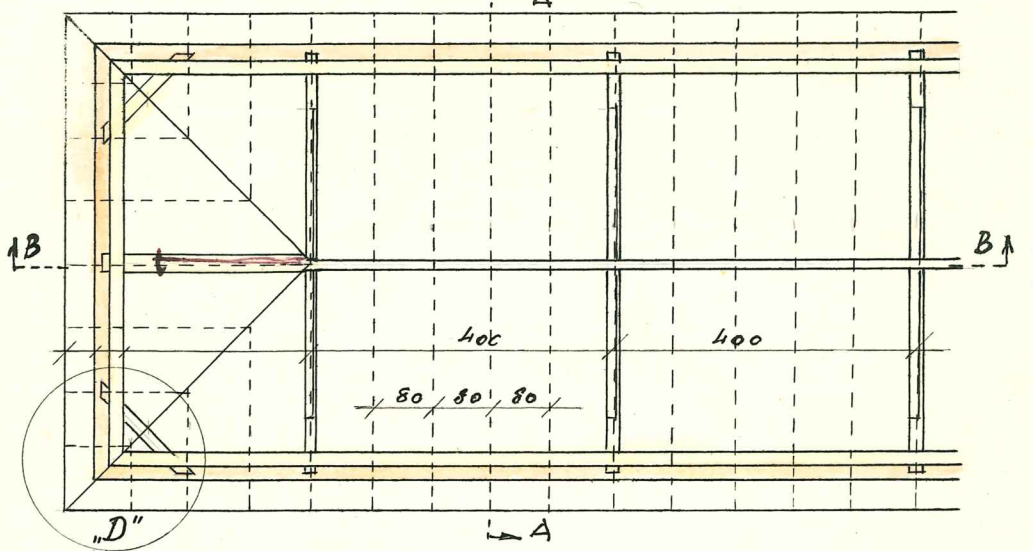

jednostruka stolica sa nedstrešnim zidom presjek

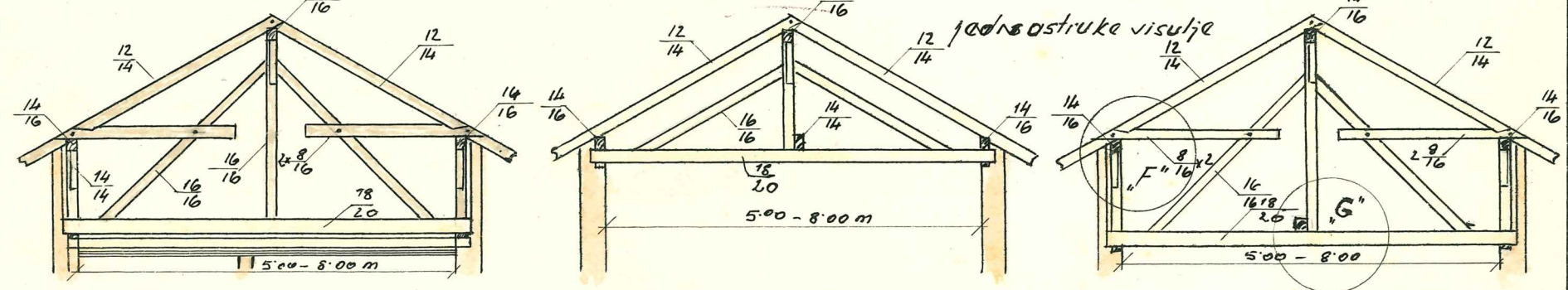

presjek B-B

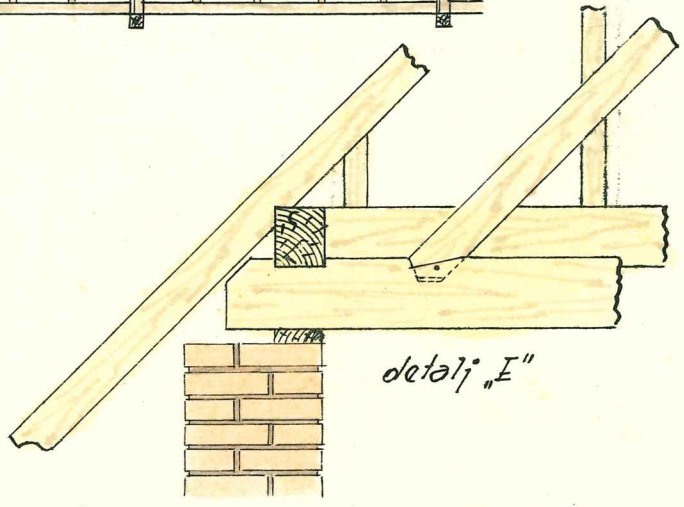
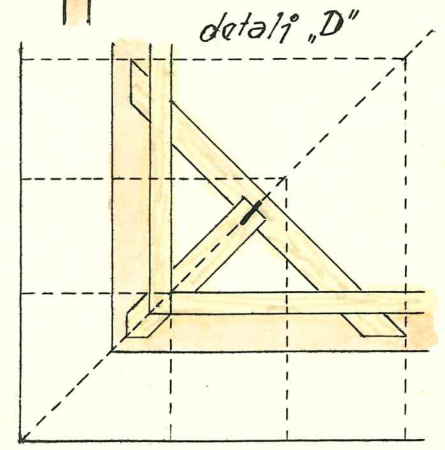
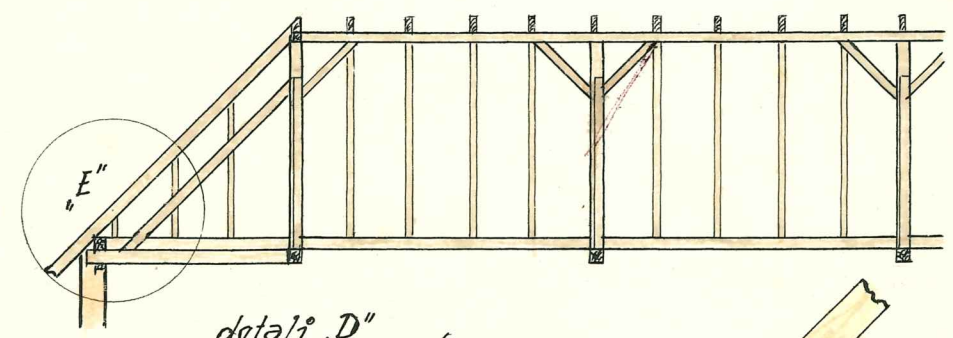

uzdužni presjek.

